

# **PRIVACY SHADES**

## **Seat Leon 5 Door 2014**

**SEA-LEON-5-D**  
**Installation Instructions**



**Privacy Shades**  
**Unit 1 Queens Court**  
**Fletcher Way**  
**Mansfield**  
**Nottinghamshire**  
**United Kingdom**  
**NG19 0FN**

**+44 (0)1623 428 882**  
**[info@car-shades.com](mailto:info@car-shades.com)**

## INSTALLATION INSTRUCTIONS

SEAT LEON 5 DOOR 2014

SEA-LEA-5-E

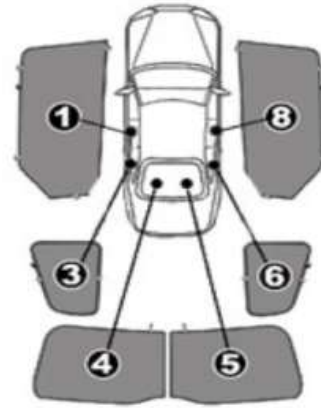

### COMPONENTS INCLUDED

#### SHADES

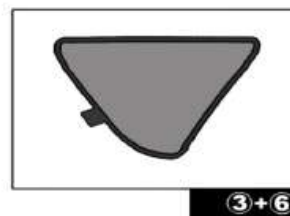
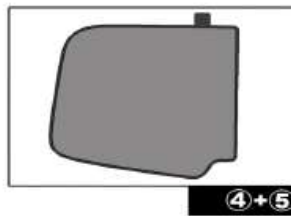
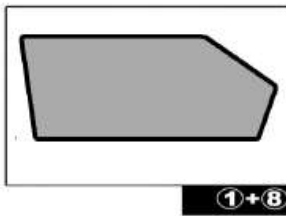

#### FIXING CLIPS

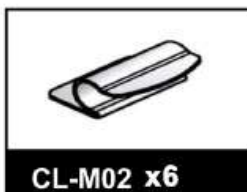

SIDE SHADE INSTALLATION

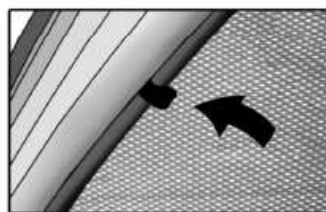
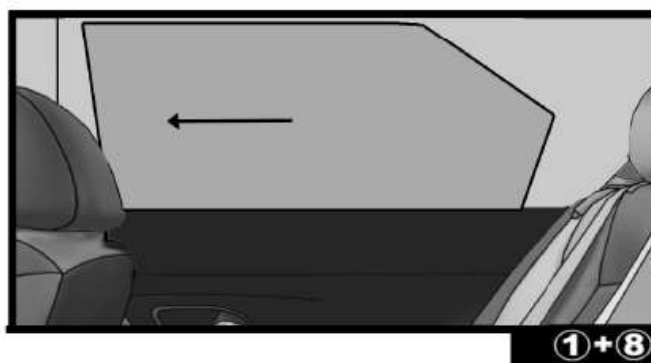
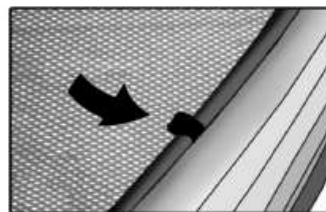
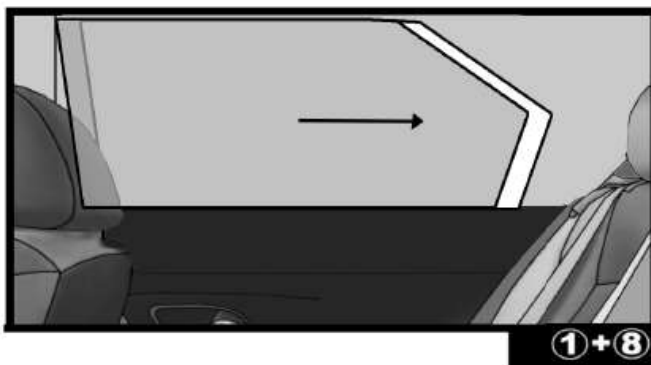
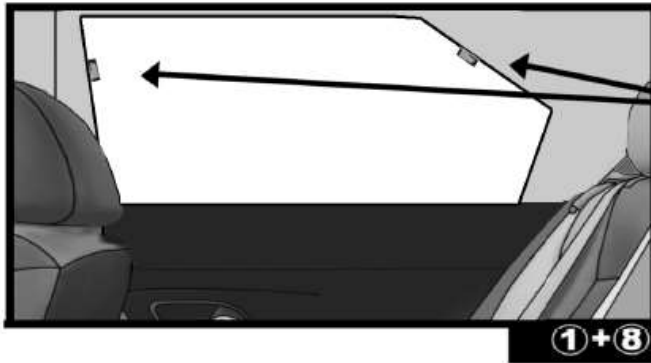

QUARTER LIGHT SHADE INSTALLATION

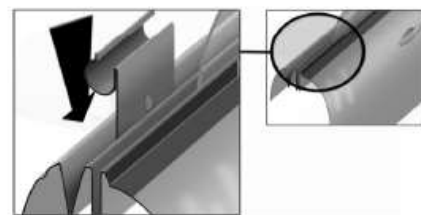
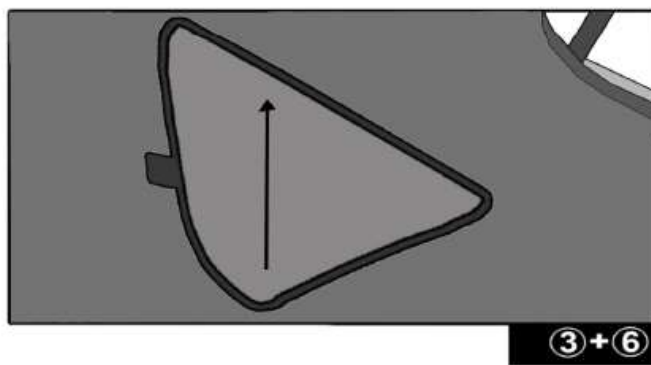
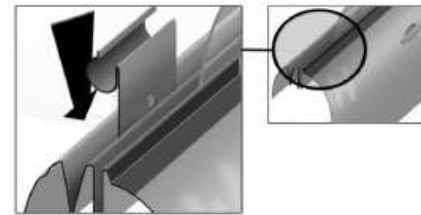
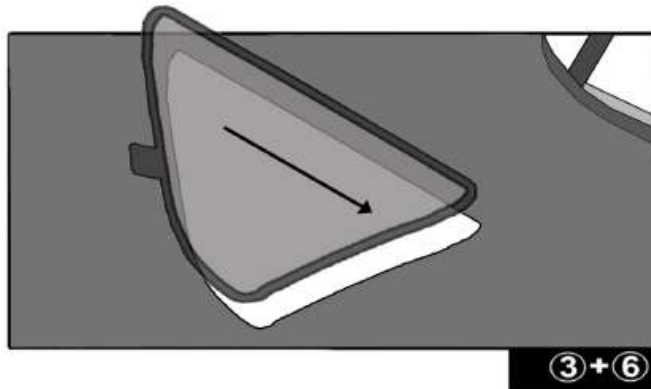
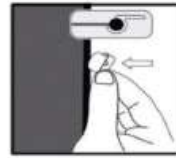
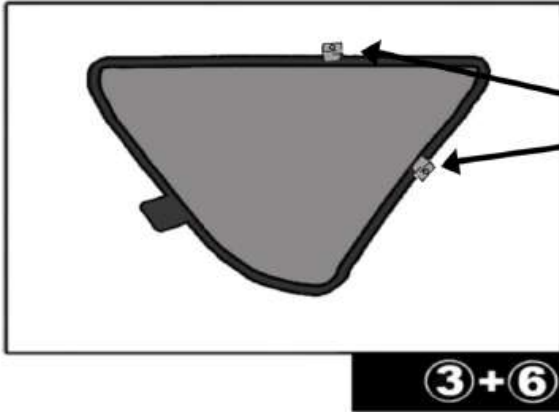

REAR SHADE INSTALLATION

