

# INSTALLATION INSTRUCTIONS

MINI COUNTRYMAN

MIN-COUN-5-A

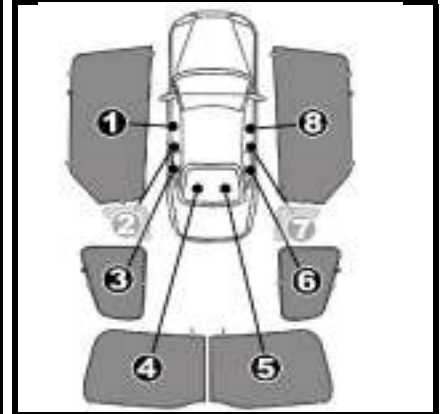

## COMPONENTS INCLUDED

### SHADES

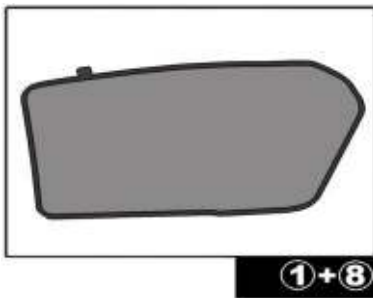

1+8

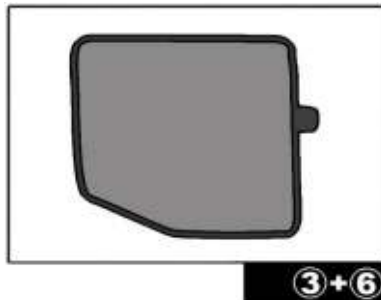

3+6

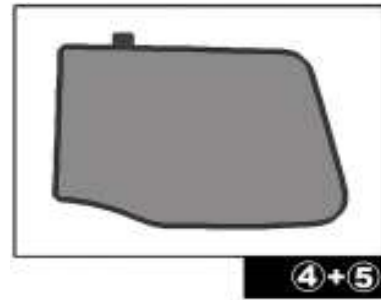

4+5

### FIXING CLIPS

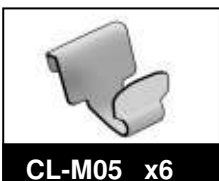

CL-M05 x6



CL-M02 x6

SIDE SHADE INSTALLATION

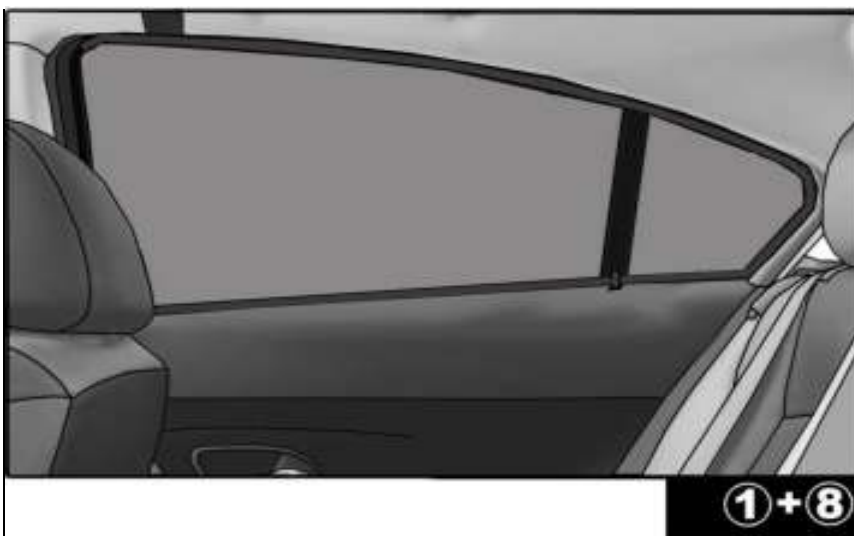
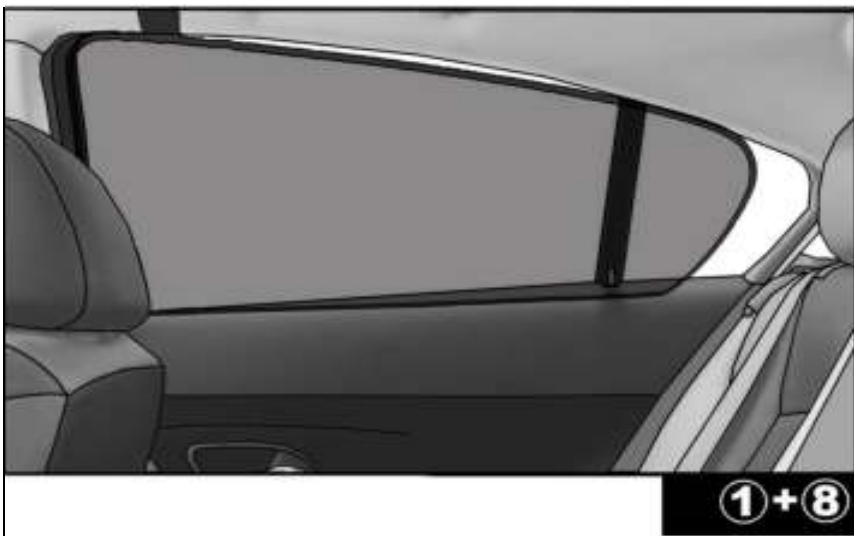
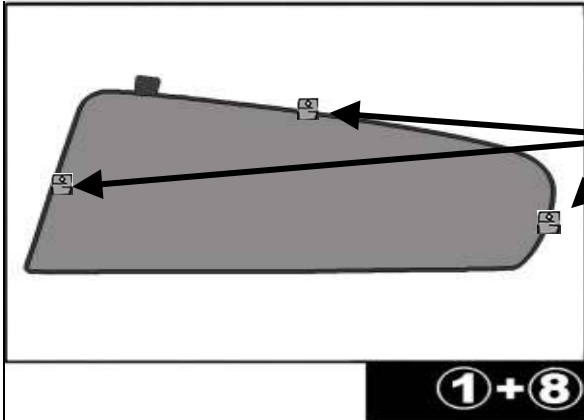

QUARTER LIGHT SHADE INSTALLATION

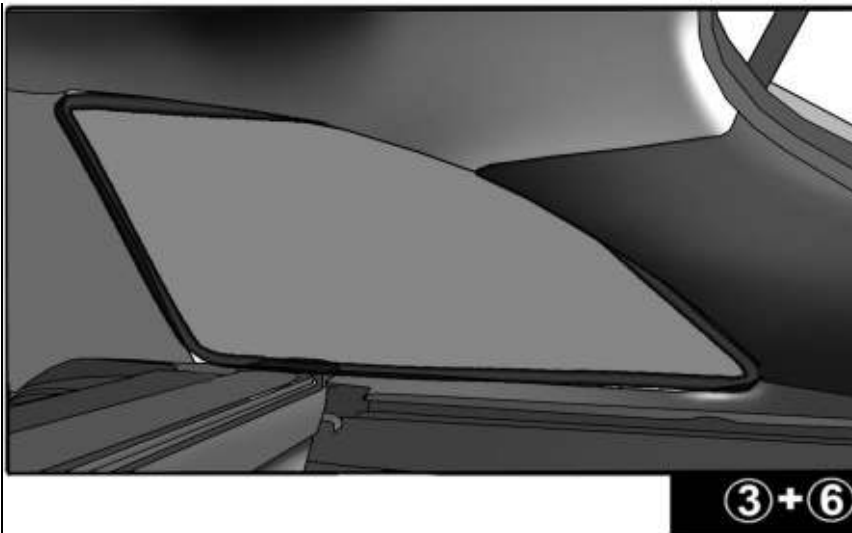
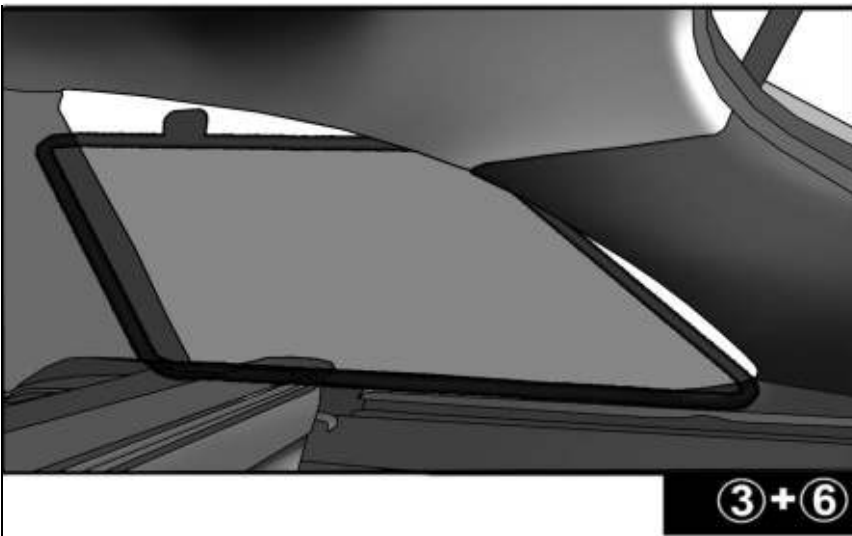
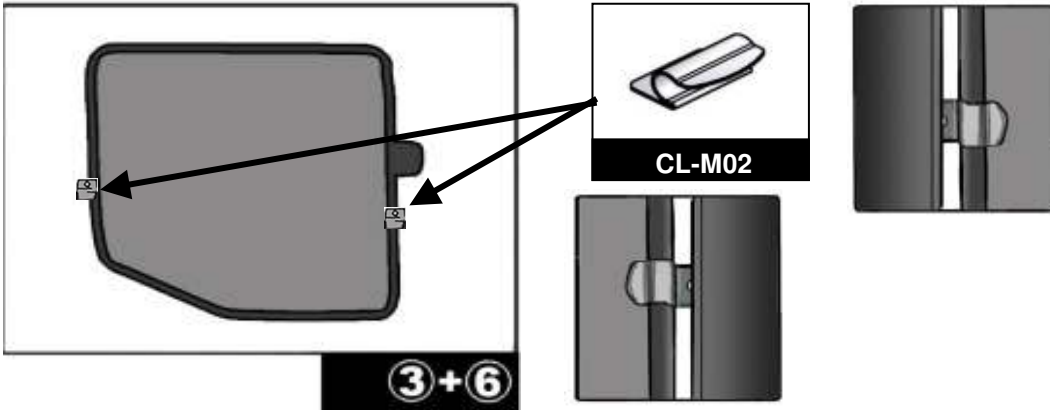

REAR SHADE INSTALLATION

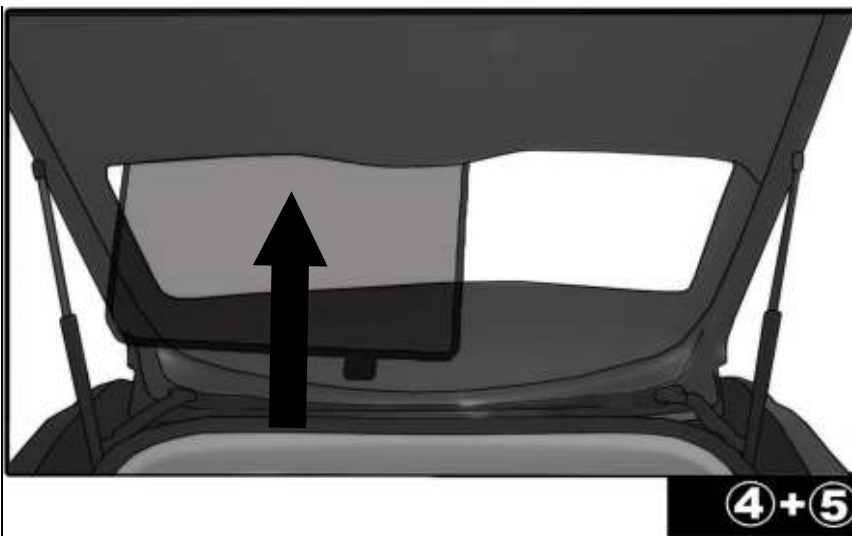
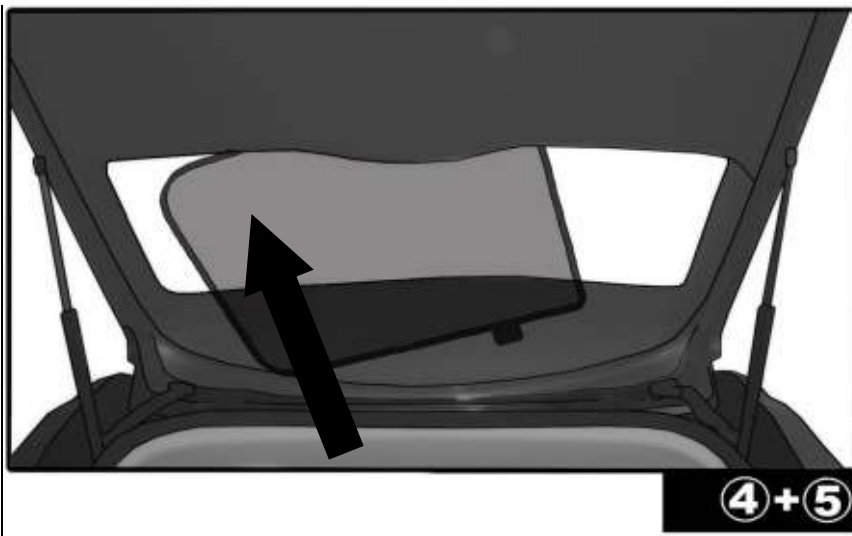
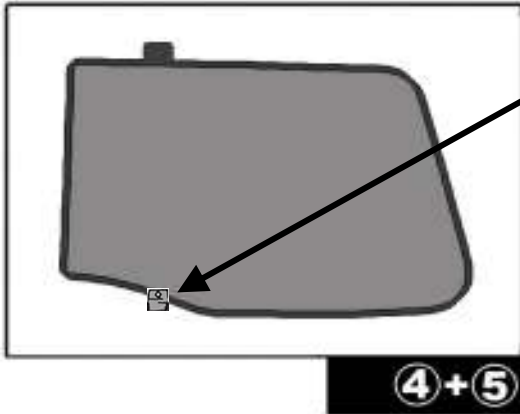

REAR SHADE INSTALLATION

